

### Features

- Output current is 1A
- Range of operation input voltage: 15V
- Line regulation: 0.03%/V (typ.)
- Standby current: 2mA (typ.)
- Load regulation: 0.2%/A (typ.)
- Environment Temperature: -20°C~85°C

### Applications

- Power Management for Computer Mother Board, Graphic Card
- LCD Monitor and LCD TV
- DVD Decode Board
- ADSL Modem
- Post Regulators for Switching Supplies

### General Description

AMS1117 is a series of low dropout three-terminal regulators with a dropout of 1.3V at 1A load current. AMS1117 features a very low standby current 2mA compared to 5mA of competitor.

Other than a fixed version,  $V_{out} = 1.2V, 1.5V, 1.8V, 2.5V, 2.85V, 3.3V,$  and 5V, AMS1117 has an adjustable version, which can provide an output voltage from 1.25 to 12V with

only two external resistors.

AMS1117 offers thermal shut down function, to assure the stability of chip and power system. And it uses trimming technique to guarantee output voltage accuracy within

2%. Other output voltage accuracy can be customized on demand, such as 1%.

AMS1117 is available in SOT-223, TO-252 power package.

### Typical Application

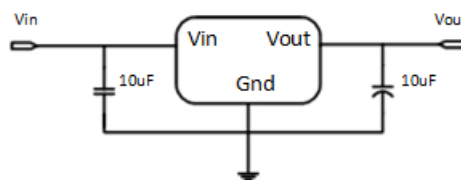

Application circuit of AMS1117 fixed version

### Typical Electrical Characteristic

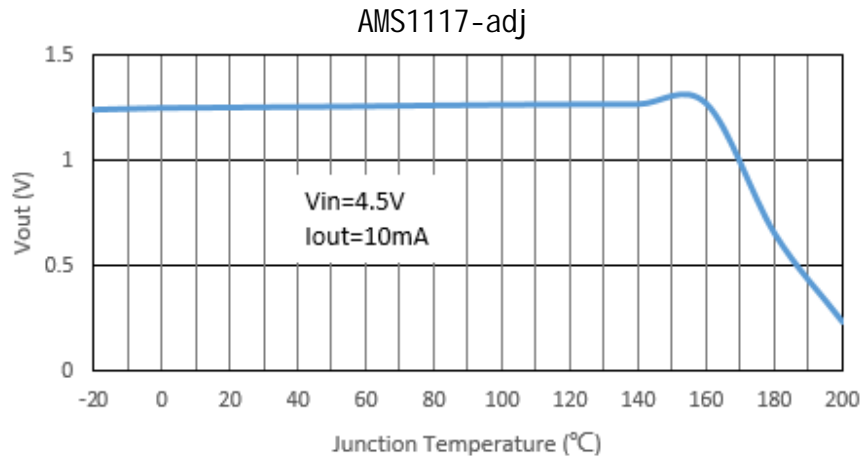

### Selection Table

Marking	Part No.	Output Voltage	Package
1117 XX YYWW	XX=12	1.2V	SOT-223 TO-252
	XX=15	1.5V	
	XX=18	1.8V	
	XX=28	2.85V	
	XX=25	2.5V	
	XX=33	3.3V	
	XX=50	5.0V	
	XX=ADJ	Adj	

### Ordering Information

Marking	Designator	Description
1117 XX YYWW	1117	Product code
	XX	Output Voltage(1.2~12.0V)
	YYWW	DATE CODE

Note: "XX" stands for output voltages. Other voltages can be specially customized

### Block Diagram

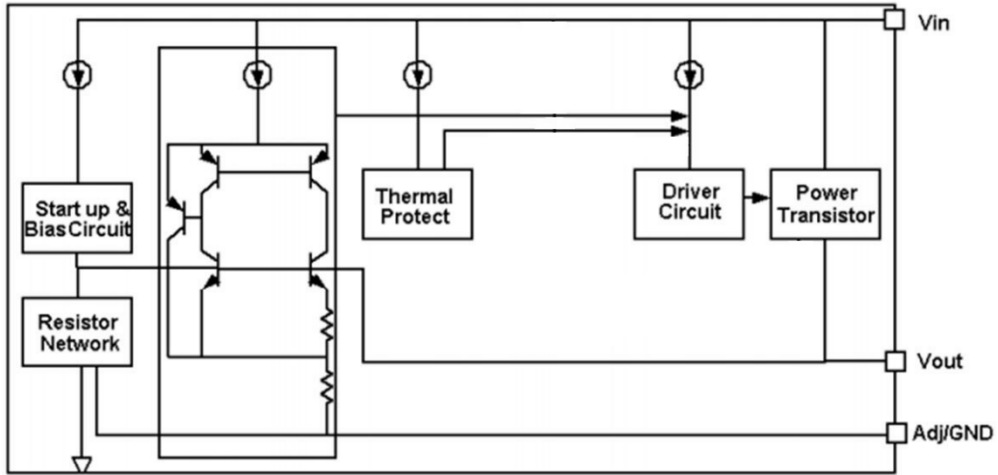

### Pin Configuration

SOT223 (Top View)



Table1: AMS1117 series (SOT223 PKG)

PIN NO.	PIN NAME	FUNCTION
1	VSS/ADJ	VSS/ADJ pin
2	VOUT	Output voltage pin
3	VIN	Input voltage pin
4	VOUT	Output voltage pin

TO252 (Top View)

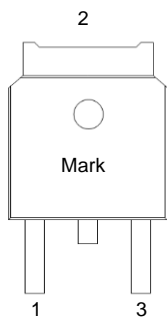

Table2: AMS1117 series (TO252 PKG)

PIN NO.	PIN NAME	FUNCTION
1	VSS/ADJ	VSS/ADJ pin
2	VOUT	Output voltage pin
3	VIN	Input voltage pin

### Absolute Maximum Ratings

Max Input Voltage ..... 18V  
 Max Operating Junction Temperature(Tj) ..... 150°C  
 Ambient Temperature(Ta) ..... -20°C~ 85°C  
 Storage Temperature(Ts) ..... -40°C~150°C  
 Lead Temperature & Time ..... 260°C 10S  
 Caution: Exceed these limits to damage to the device. Exposure to absolute maximum rating conditions may affect device reliability.

### Electrical Characteristics

T<sub>A</sub>=25°C, unless otherwise noted.

Symbol	Parameter	Conditions	Min	Typ	Max	Unit
V <sub>in</sub>	Input voltage		--	15	18	V
V <sub>ref</sub>	Reference voltage	AMS1117-Adj 10mA ≤ I <sub>out</sub> ≤ 1A, V <sub>in</sub> =3.25V	1.225	1.25	1.275	V
V <sub>out</sub>	Output voltage	AMS1117-1.2V 0 ≤ I <sub>out</sub> ≤ 1A, V <sub>in</sub> =2.7V	1.176	1.2	1.224	V
		AMS1117-1.5V 0 ≤ I <sub>out</sub> ≤ 1A, V <sub>in</sub> =3.0V	1.47	1.5	1.53	V
		AMS1117-1.8V 0 ≤ I <sub>out</sub> ≤ 1A, V <sub>in</sub> =3.3V	1.764	1.8	1.836	V
		AMS1117-2.5V 0 ≤ I <sub>out</sub> ≤ 1A, V <sub>in</sub> =4.0V	2.45	2.5	2.55	V
		AMS1117-2.85V 0 ≤ I <sub>out</sub> ≤ 1A, V <sub>in</sub> =4.35V	2.793	2.85	2.907	V
		AMS1117-3.3V 0 ≤ I <sub>out</sub> ≤ 1A, V <sub>in</sub> =4.8V	3.234	3.3	3.366	V
		AMS1117-5.0V 0 ≤ I <sub>out</sub> ≤ 1A, V <sub>in</sub> =6.5V	4.9	5	5.1	V

ΔV <sub>out</sub>	Line regulation	AMS1117-1.2V I <sub>out</sub> =10mA, 2.7V ≤ V <sub>in</sub> ≤ 10V		4	19	mV
		AMS1117-1.5V I <sub>out</sub> =10mA, 3.0V ≤ V <sub>in</sub> ≤ 10V		5	26	mV
		AMS1117-ADJ I <sub>out</sub> =10mA, 2.75V ≤ V <sub>in</sub> ≤ 12V		5	24	mV
		AMS1117-1.8V I <sub>out</sub> =10mA, 3.3V ≤ V <sub>in</sub> ≤ 12V		5	32	mV

		AMS1117-2.5V $I_{out}=10mA, 4.0V \leq V_{in} \leq 12V$		8	41	mV
		AMS1117-2.85V $I_{out}=10mA, 4.35V \leq V_{in} \leq 12V$		8	46	mV
		AMS1117-3.3V $I_{out}=10mA, 4.8V \leq V_{in} \leq 12V$		9	49	mV
		AMS1117-5.0V $I_{out}=10mA, 6.5V \leq V_{in} \leq 12V$		10	56	mV

$\Delta V_{out}$	Load regulation	AMS1117-1.2V $V_{in} = 2.7V, 10mA \leq I_{out} \leq 1A$		3	8	mV
		AMS1117-1.5V $V_{in} = 3.0V, 10mA \leq I_{out} \leq 1A$		3	8	mV
		AMS1117-ADJ $V_{in} = 2.75V, 10mA \leq I_{out} \leq 1A$		4	8	mV
		AMS1117-1.8V $V_{in} = 3.3V, 10mA \leq I_{out} \leq 1A$		4	12	mV
		AMS1117-2.5V $V_{in} = 4.0V, 10mA \leq I_{out} \leq 1A$		5	16	mV
		AMS1117-2.85V $V_{in} = 4.35V, 10mA \leq I_{out} \leq 1A$		6	20	mV
		AMS1117-3.3 $V_{in} = 4.8V, 10mA \leq I_{out} \leq 1A$		7	24	mV
		AMS1117-5.0 $V_{in} = 6.5V, 10mA \leq I_{out} \leq 1A$		10	36	mV
		Vdrop	Dropout voltage	$I_{out} = 100mA$		1.15
$I_{out} = 1A$				1.3	1.5	V
Imin	Minimum load current	AMS1117-ADJ		2	10	mA
Iq	Quiescent Current	AMS1117-1.2V, $V_{in} = 10V$		2	5	mA
		AMS1117-1.5V, $V_{in} = 10V$		2	5	mA
		AMS1117-1.8V, $V_{in} = 12V$		2	5	mA
		AMS1117-2.5V, $V_{in} = 12V$		2	5	mA
		AMS1117-2.85V, $V_{in} = 12V$		2	5	mA
		AMS1117-3.3V, $V_{in} = 12V$		2	5	mA
		AMS1117-5.0V, $V_{in} = 12V$		2	5	mA
Iadj	Adjust pin current	AMS1117-ADJ $V_{in} = 5V, 10mA \leq I_{out} \leq 1A$		55	120	$\mu A$
Ichange	Iadj change	AMS1117-ADJ		0.2	10	$\mu A$

		Vin=5V, 10mA ≤ Iout ≤ 1A				
OTP	Thermal Shutdown	Junction Temperature		+200		°C
	Thermal Shutdown Hysteresis	Junction Temperature		+30		°C
Δ Vout	Temperature coefficient	Vin=4.5V, Iout=10mA VOUT=3.3V 20°C ≤ Ta ≤ 120°C		30		mV
θ JC	Thermal resistance	SOT-223		20		°C/W
		TO-252		10		

Note1: All test are conducted under ambient temperature 25° C and within a short period of time 20ms

Note2: Load current smaller than minimum load current of AMS1117-ADJ will lead to unstable or oscillation output.

### Detailed Description

AMS1117 is a series of low dropout voltage, three terminal regulators. Its application circuit is very simple: the fixed version only needs two capacitors and the adjustable version only needs two resistors and two capacitors to work. It is composed of some modules including start-up circuit, bias circuit, bandgap, thermal shutdown, power transistors and its driver circuit and so on.

The thermal shut down modules can assure chip and its application system working safety when the junction temperature is larger than 140°C.

The bandgap module provides stable reference voltage, whose temperature coefficient is compensated by careful design considerations. The temperature coefficient is under 100 ppm/°C. And the accuracy of output voltage is guaranteed by trimming technique.

### Typical Application

AMS1117 has an adjustable version and six fixed versions (1.2V, 1.5V, 1.8V, 2.5V, 2.85V, 3.3V and 5V) **Fixed Output Voltage Version**

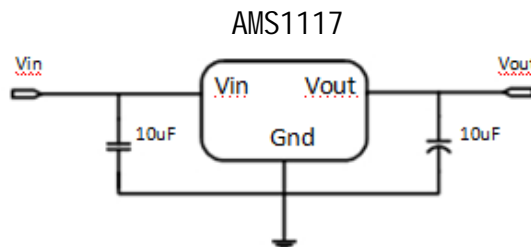

Application circuit of AMS1117 fixed version

- 1) Recommend using 10uF tan capacitor as bypass capacitor (C1) for all application circuit.
- 2) Recommend using 10uF tan capacitor to assure circuit stability.

### Adjustable Output Voltage Version

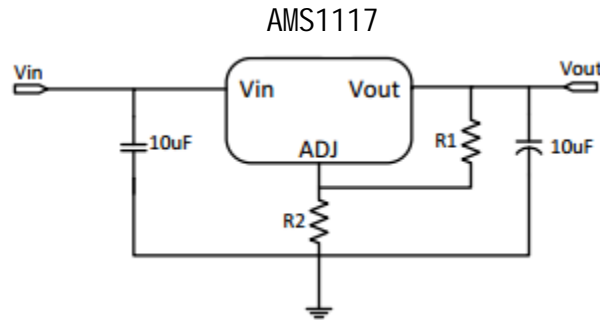

Application Circuit of AMS1117-ADJ

The output voltage of adjustable version follows the equation:  $V_{out} = 1.25 \times (1 + R2/R1) + I_{Adj} \times R2$ . We can ignore  $I_{Adj}$  because  $I_{Adj}$  (about 50uA) is much less than the current of  $R1$  (about 2~10mA).

- 1) To meet the minimum load current (>10mA) requirement,  $R1$  is recommended to be 125ohm or lower. As AMS1117-ADJ can keep itself stable at load current about 2mA,  $R1$  is not allowed to be higher than 625ohm.
- 2) Using a bypass capacitor ( $C_{ADJ}$ ) between the ADJ pin and ground can improve ripple rejection. This bypass capacitor prevents ripple from being amplified as the output voltage is increased. The impedance of  $C_{ADJ}$  should be less than  $R1$  to prevent ripple from being amplified. As  $R1$  is normally in the range of 100Ω~500Ω, the value of  $C_{ADJ}$  should satisfy this equation:  $1/(2\pi \times f_{ripple} \times C_{ADJ}) < R1$ .

### Thermal Considerations

We have to take heat dissipation into great consideration when output current or differential voltage of input and output voltage is large. Because in such cases, the power dissipation consumed by AMS1117 is very large. AMS1117 series uses SOT-

223 package type and its thermal resistance is about 20°C/W. And the copper area of application board can affect the total thermal resistance. If copper area is 5cm\*5cm (two sides), the resistance is about 30°C/W. So the total thermal resistance is about 20°C/W + 30°C/W. We can decrease total thermal resistance by increasing copper area in application board. When there is no good heat dissipation copper area in PCB, the total thermal resistance will be as high as 120°C/W, then the power dissipation of AMS1117 could allow on itself is less than 1W. And furthermore, AMS1117 will work at junction

temperature higher than 125°C under such condition and no lifetime is guaranteed.

### Typical Performance Characteristics

$T_A=25^\circ\text{C}$ , unless otherwise noted

#### Line Regulation vs. Junction Temperature

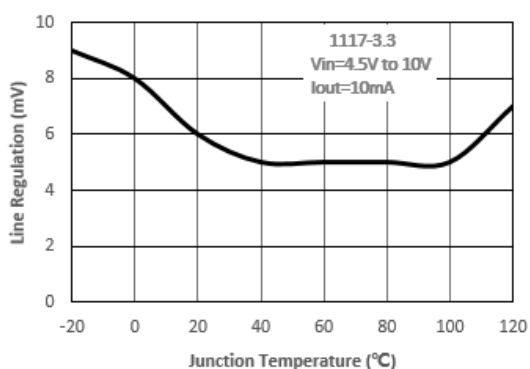

#### Load Regulation vs. Junction Temperature

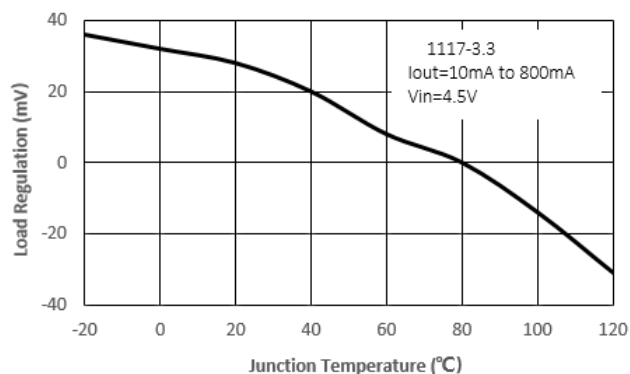

#### Reference Voltage vs. Junction Temperature

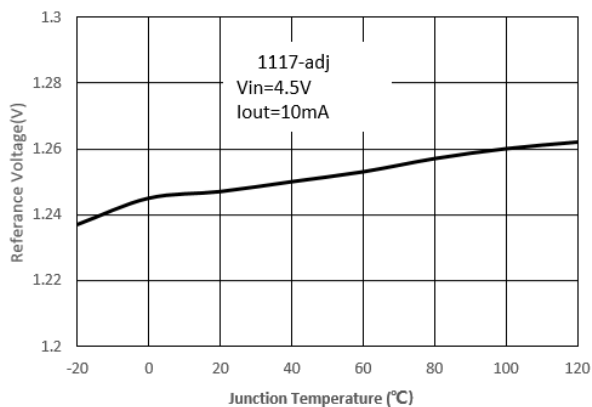

#### Output Voltage vs. Junction Temperature

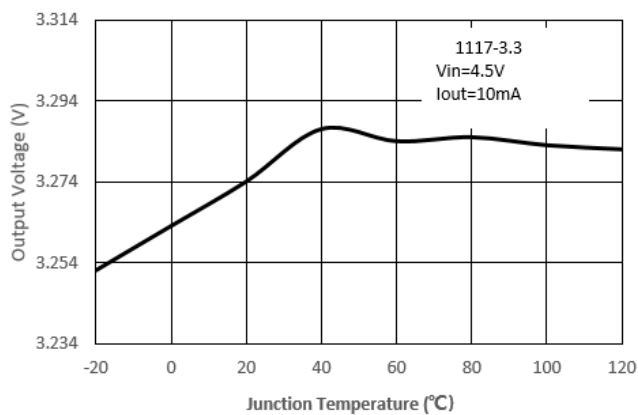

#### Minimum Load Current vs. Junction Temperature

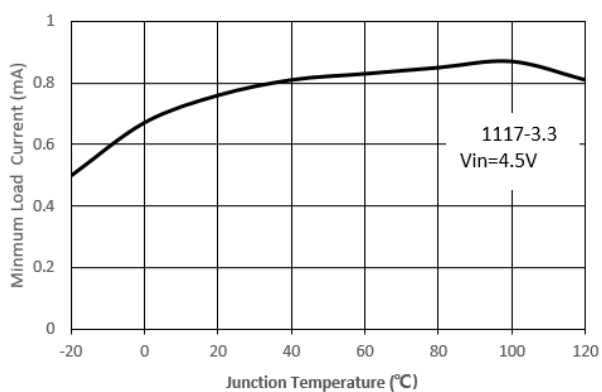

#### Adjust Pin Current vs. Junction Temperature

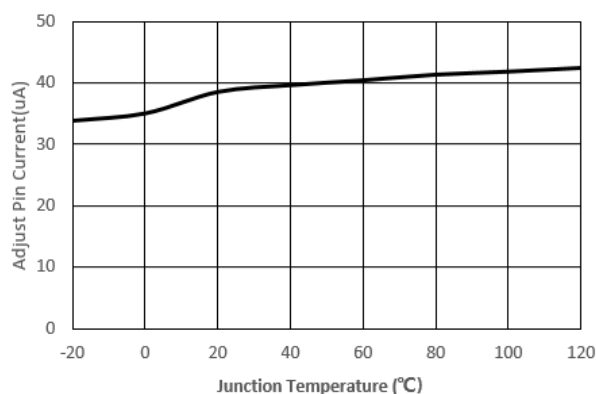



PSRR vs. Frequency

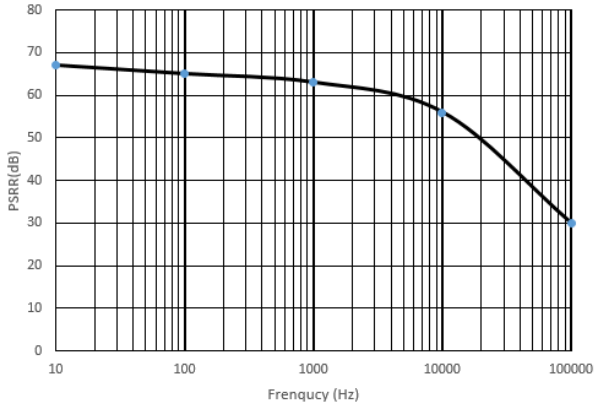

Dropout Voltage vs. Output Current

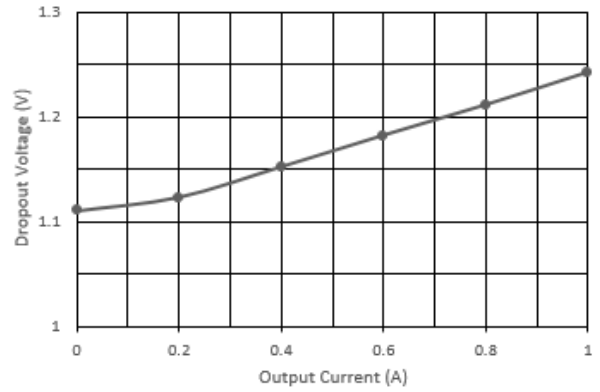

Line Transient Response

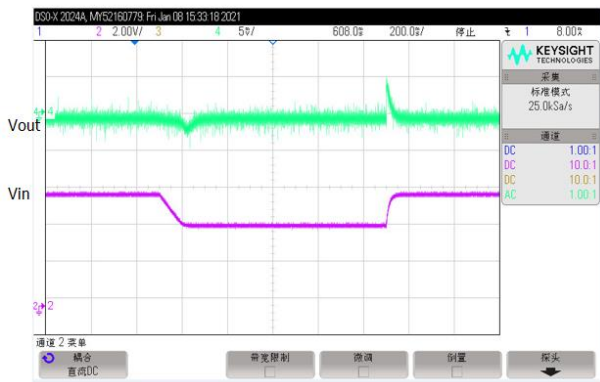

Load Transient Response

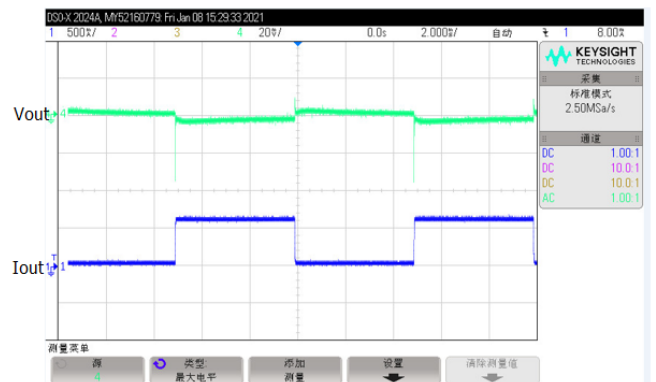

### Package Information

SOT-223 PACKAGE OUTLINE DIMENSIONS

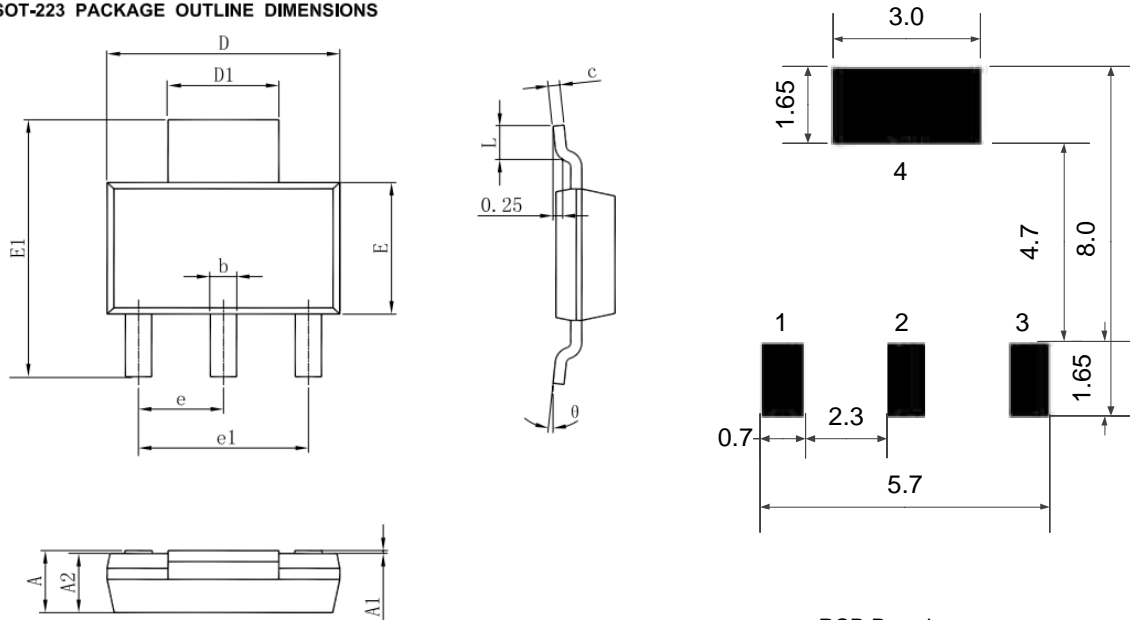

PCB Board

Symbol	Dimensions In Millimeters		Dimensions In Inches	
	Min	Max	Min	Max
A	1.520	1.800	0.060	0.071
A1	0.000	0.100	0.000	0.004
A2	1.500	1.700	0.059	0.067
b	0.660	0.820	0.026	0.032
c	0.250	0.350	0.010	0.014
D	6.200	6.400	0.244	0.252
D1	2.900	3.100	0.114	0.122
E	3.300	3.700	0.130	0.146
E1	6.830	7.070	0.269	0.278
e	2.300(BSC)		0.091(BSC)	
e1	4.500	4.700	0.177	0.185
L	0.900	1.150	0.035	0.045
$\theta$	0°	10°	0°	10°

TO-252-2L PACKAGE OUTLINE DIMENSIONS

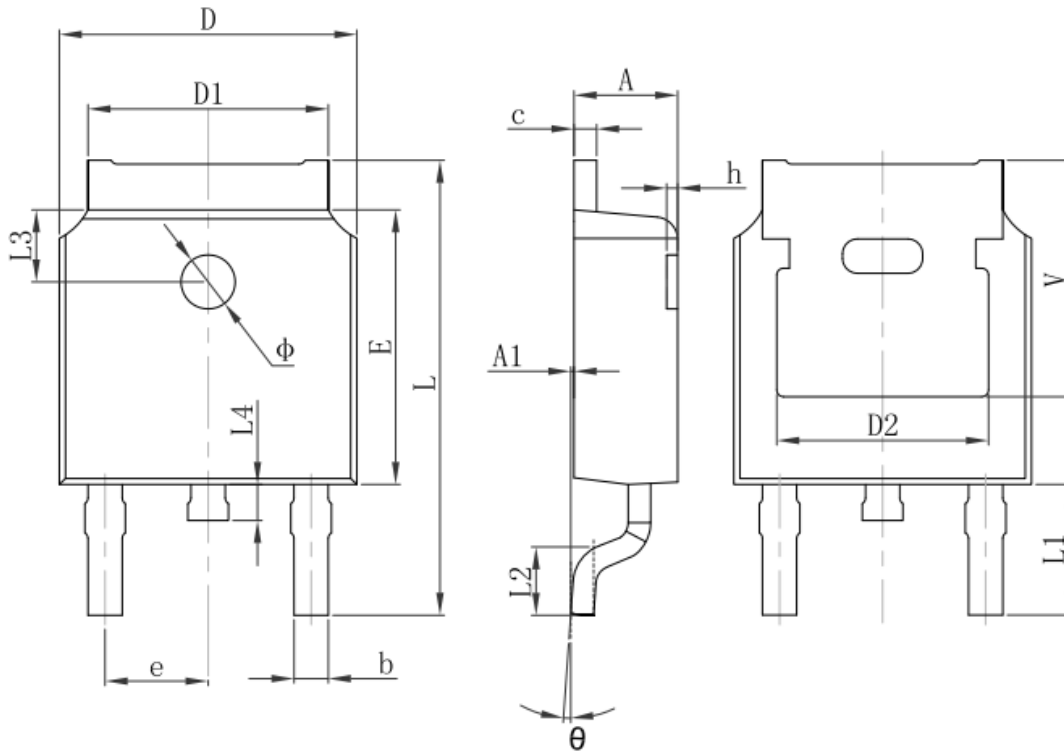

Symbol	Dimensions In Millimeters		Dimensions In Inches	
	Min.	Max.	Min.	Max.
A	2.200	2.400	0.087	0.094
A1	0.000	0.127	0.000	0.005
b	0.660	0.860	0.026	0.034
c	0.460	0.580	0.018	0.023
D	6.500	6.700	0.256	0.264
D1	5.100	5.460	0.201	0.215
D2	4.830 REF.		0.190 REF.	
E	6.000	6.200	0.236	0.244
e	2.186	2.386	0.086	0.094
L	9.800	10.400	0.386	0.409
L1	2.900 REF.		0.114 REF.	
L2	1.400	1.700	0.055	0.067
L3	1.600 REF.		0.063 REF.	
L4	0.600	1.000	0.024	0.039
φ	1.100	1.300	0.043	0.051
θ	0°	8°	0°	8°
h	0.000	0.300	0.000	0.012
V	5.350 REF.		0.211 REF.	